

6184

Angle de pas
Schrittwinkel
Step angle 15 °

Diamètre
Durchmesser
Diameter 35 mm

Poids
Gewicht
Weight 75 g

Couple de retenue
Haltemoment 15.5/12 mNm
Holding torque

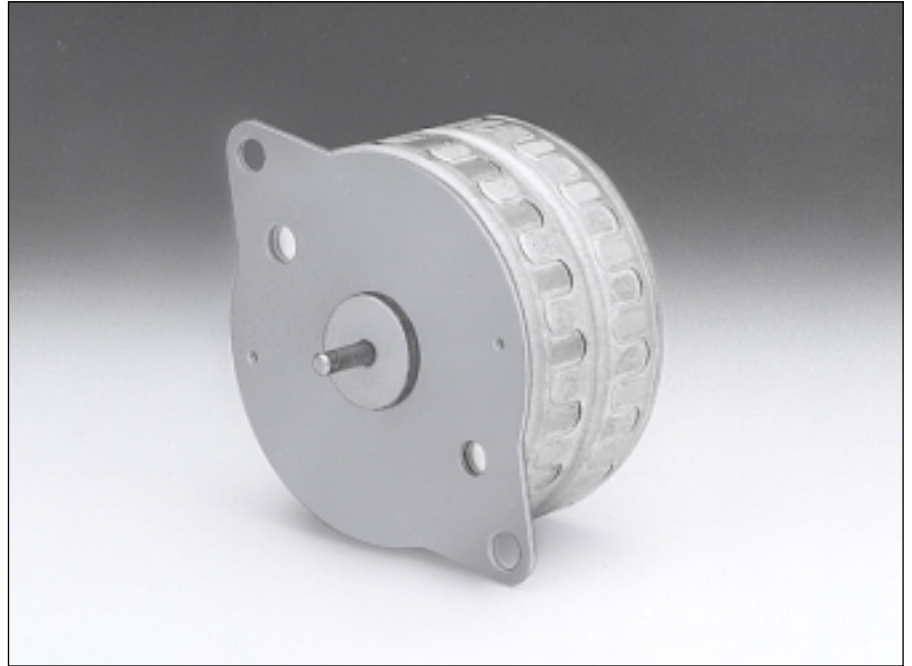

		Résistance de phase Phasenwiderstand Phase resistance Ω	Induct. de phase Phaseninduktivität Phase inductance mH	Courant de phase Phasenstrom Phase current A	Couple de retenue Haltemoment Holding torque mNm	Puissance nominale Nennleistung Nominal power W	Code câble Kabelcode Cable-code	
bipolar	6184-2-20	20	24	0.28	15.5	3.1	rouge rot red	
	6184-2-80	80	93	0.14	15.5	3.1	bleu blau blue	
	6184-2-320	320	370	0.07	15.5	3.1	vert grün green	
unipolar	6184-4-20	20	13	0.28	12.0	3.1	rouge rot red	
	6184-4-80	80	48	0.14	12.0	3.1	bleu blau blue	
	6184-4-320	320	200	0.07	12.0	3.1	vert grün green	

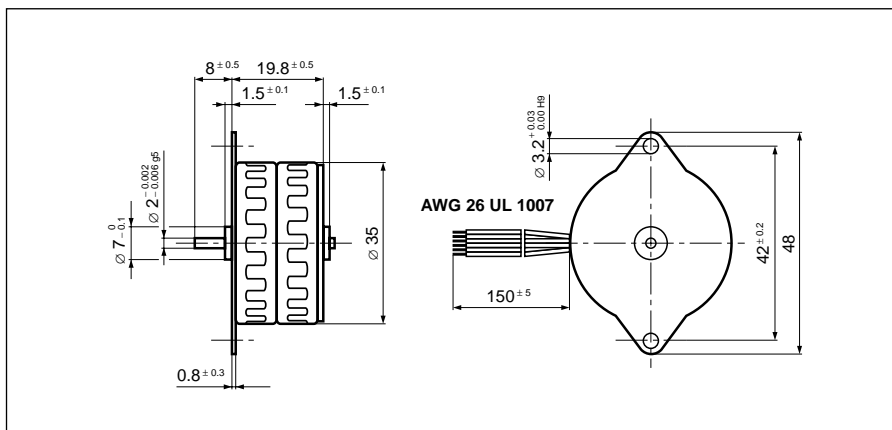

Pas/ Schritte/U Steps/rev	24
Précision/pas Schrittgenauigkeit Step accuracy	± 7 %
Inertie du rotor Rotorträgheitsmoment Rotor inertia	2.4 gcm²
Classe d'isolation Isolationsklasse Insulation class	E 120 °C
Protection Schutzart Protection	DIN 40050 IP 30
Tension d'essai Prüfspannung Test voltage	500 VAC
Couple résiduel Restmoment Detent torque	1.4 mNm

Caractéristiques dynamiques
Dynamische Daten
Dynamic characteristics

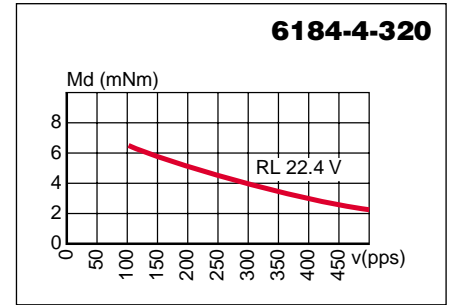
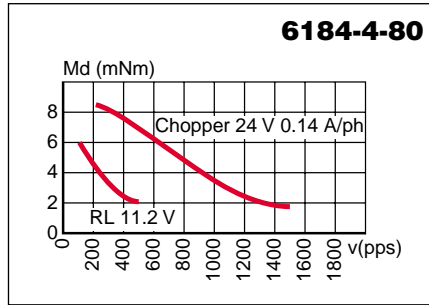
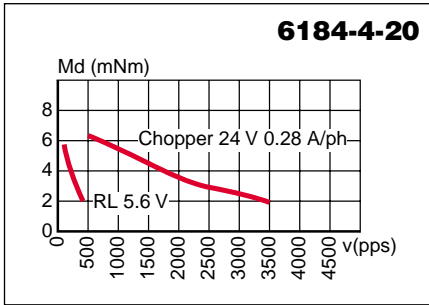
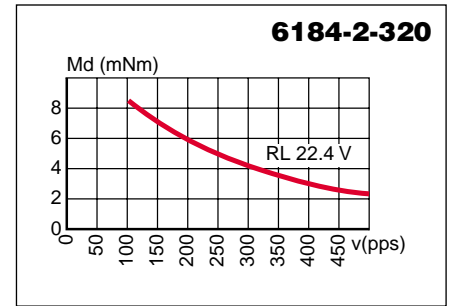
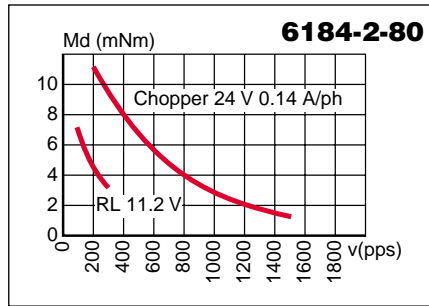
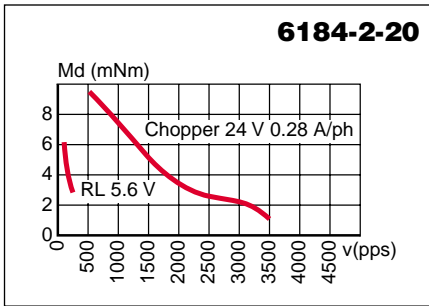

Caractéristiques statiques
Statische Daten
Static characteristics

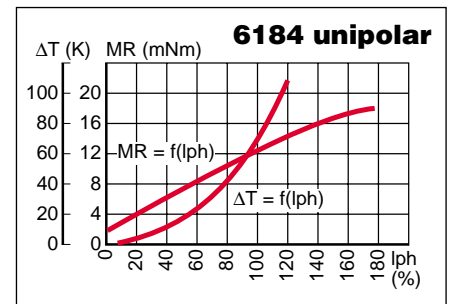
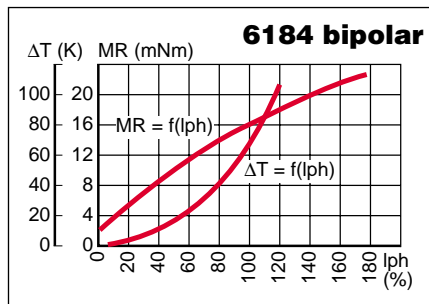

Possibilités d'exécutions adaptées sur demande.
 Auf Wunsch werden kundenspezifische Anforderungen berücksichtigt.
 Special requirements can be made to customer specification.

SONCEBOZ SA
 CH-2605 Sonceboz
 Tél: +41 32 488 11 11
 Fax: +41 32 488 11 00
 E-Mail: info@sonceboz.com
 Internet: www.sonceboz.com

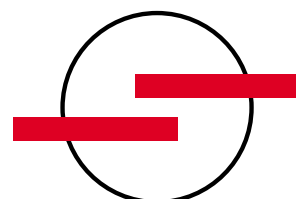

SONCEBOZ
 The driving force