

6231 S

Angle de pas
Schrittwinkel
Step angle 7.5 °

Diamètre
Durchmesser
Diameter 42 mm

Poids
Gewicht
Weight 120 g

Couple de retenue
Haltemoment
Holding torque 47/57 mNm

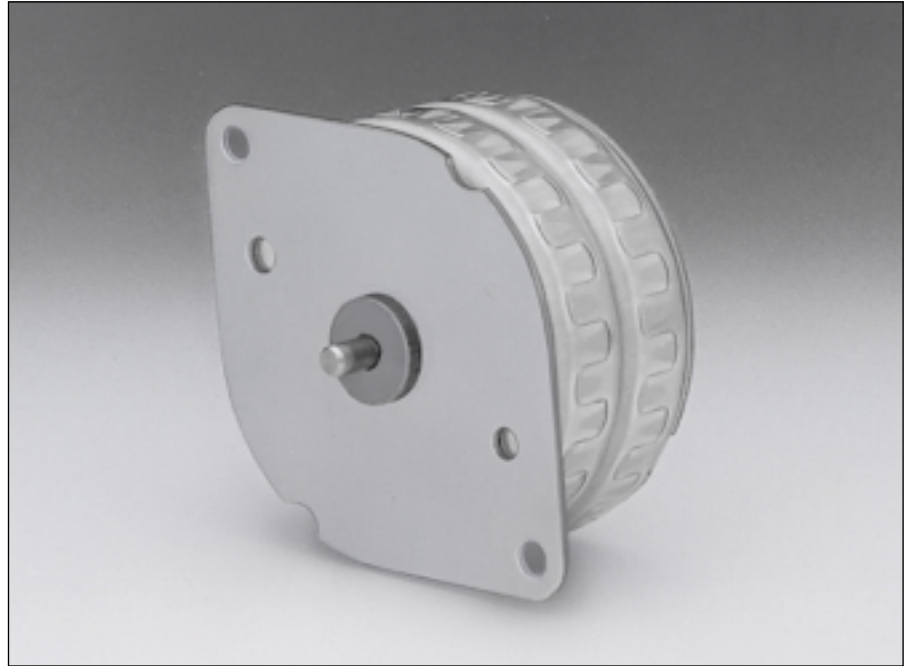

		Résistance de phase Phasenwiderstand Phase resistance Ω	Induct. de phase Phaseninduktivität Phase inductance mH	Courant de phase Phasenstrom Phase current A	Couple de retenue Haltemoment Holding torque mNm	Puissance nominale Nennleistung Nominal power W	Code câble Kabelcode Cable-code	
bipolar	6231-2S-17.5	17.5	25	0.34	57	4	rouge rot red	
	6231-2S-70	70	98	0.17	57	4	bleu blau blue	
	6231-2S-280	280	408	0.085	57	4	vert grün green	
unipolar	6231-4S-17.5	17.5	13	0.34	47	4	rouge rot red	
	6231-4S-70	70	55	0.17	47	4	bleu blau blue	
	6231-4S-280	280	226	0.085	47	4	vert grün green	

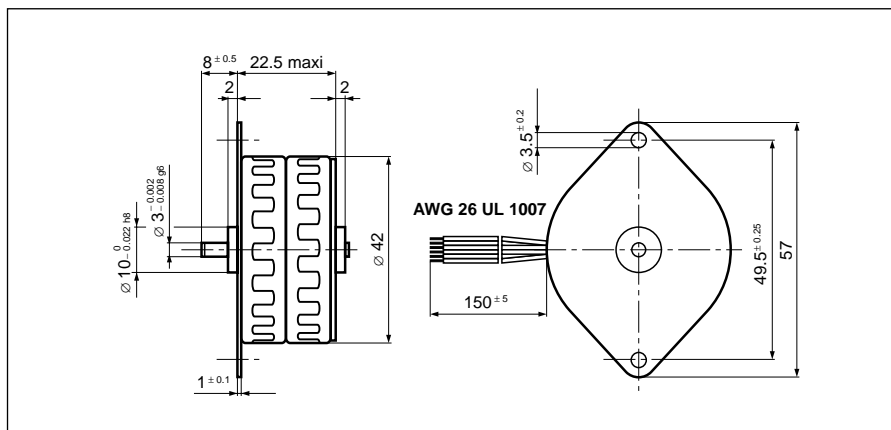

Pas/ Schritte/U Steps/rev	48
Précision/pas Schrittgenauigkeit Step accuracy	± 7 %
Inertie du rotor Rotorträgheitsmoment Rotor inertia	12 gcm²
Classe d'isolation Isolationsklasse Insulation class	E 120 °C
Protection Schutzart Protection	DIN 40050 IP 30
Tension d'essai Prüfspannung Test voltage	500 VAC
Couple résiduel Restmoment Detent torque	5 mNm

Caractéristiques dynamiques
Dynamische Daten
Dynamic characteristics

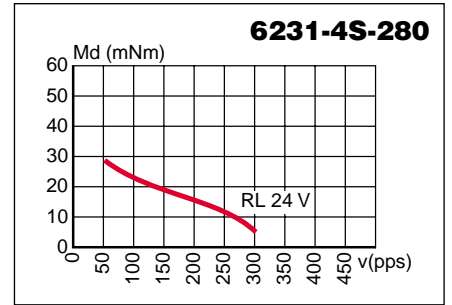
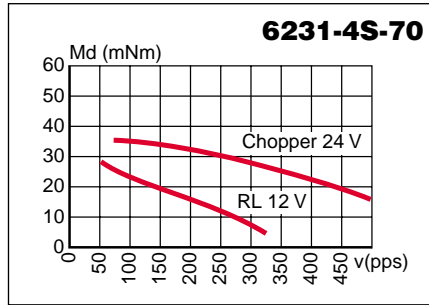
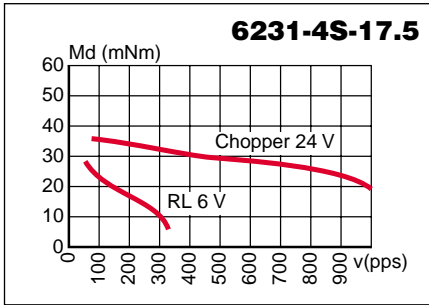
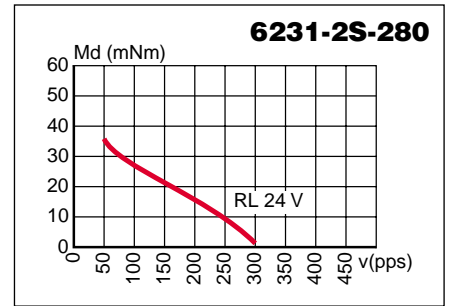
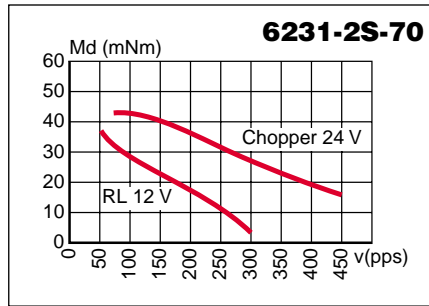
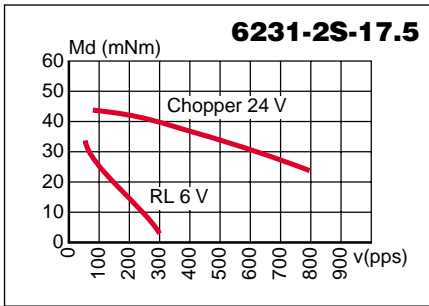

Caractéristiques statiques
Statische Daten
Static characteristics

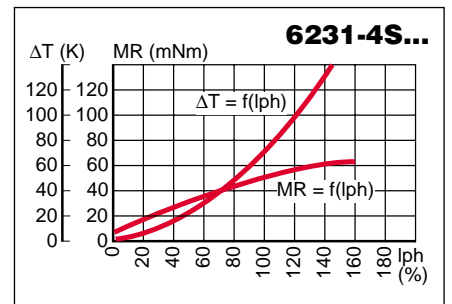
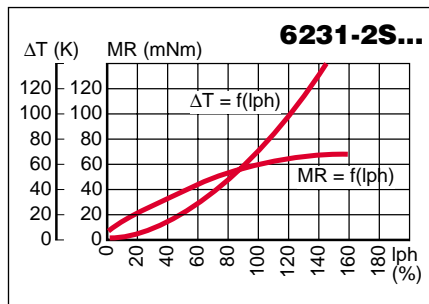

Possibilités d'exécutions adaptées sur demande.
 Auf Wunsch werden kundenspezifische Anforderungen berücksichtigt.
 Special requirements can be made to customer specification.

SONCEBOZ SA
 CH-2605 Sonceboz
 Tél: +41 32 488 11 11
 Fax: +41 32 488 11 00
 E-Mail: info@sonceboz.com
 Internet: www.sonceboz.com

