

6500-30

Angle de pas
Schrittwinkel
Step angle 1.8 °

Diamètre
Durchmesser
Diameter 57.2 mm

Poids
Gewicht
Weight 860 g

Couple de retenue
Haltemoment 1250/950 mNm
Holding torque

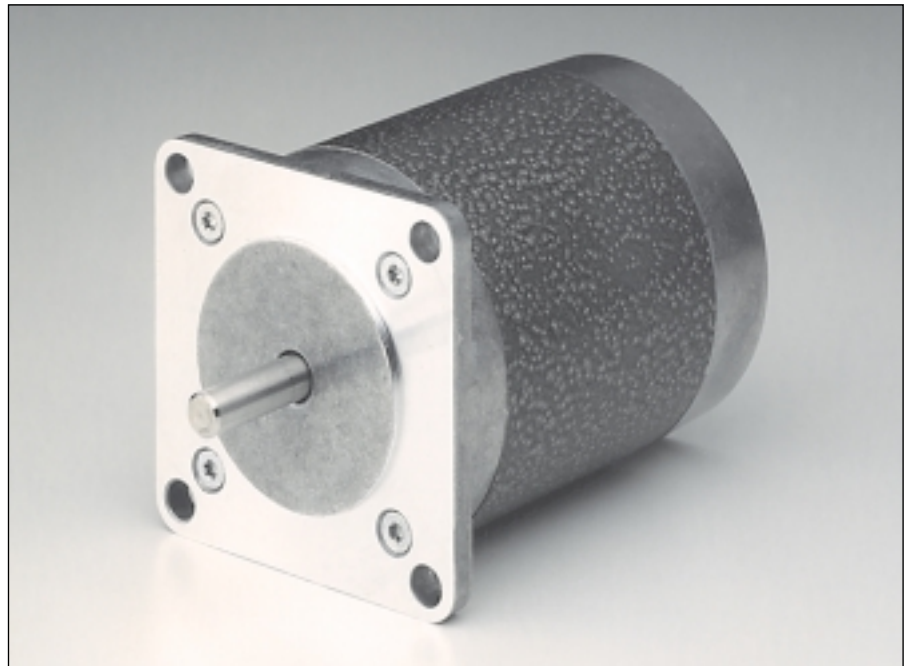

		Résistance de phase Phasenwiderstand Phase resistance Ω	Induct. de phase Phaseninduktivität Phase inductance mH	Courant de phase Phasenstrom Phase current A	Couple de retenue Haltemoment Holding torque mNm	Puissance nominale Nennleistung Nominal power W	
bipolar	6500-30-2-0.37	0.37	1.49	4.7	1250	16.3	
	6500-30-2-2.6	2.6	10.5	1.8	1250	16.8	
unipolar	6500-30-4-0.37	0.37	0.73	4.7	950	16.3	
	6500-30-4-2.6	2.6	5.6	1.8	950	16.8	

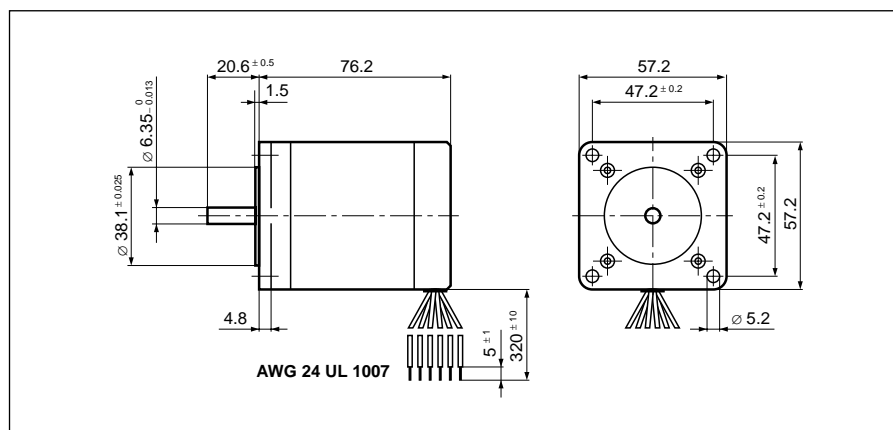

Pas/t Schritte/U Steps/rev	200
Précision/pas Schrittgenauigkeit Step accuracy	± 5 %
Inertie du rotor Rotorträgheitsmoment Rotor inertia	239 gcm²
Classe d'isolation Isolationsklasse Insulation class	B 130 °C
Protection Schutzart Protection	DIN 40050 IP 30
Tension d'essai Prüfspannung Test voltage	500 VAC
Couple résiduel Restmoment Detent torque	64 mNm

Caractéristiques dynamiques
Dynamische Daten
Dynamic characteristics

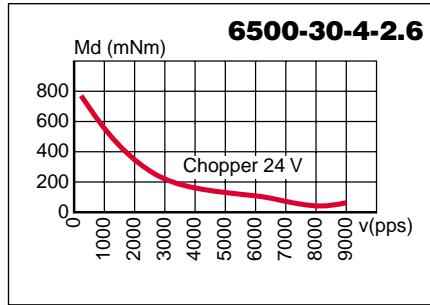
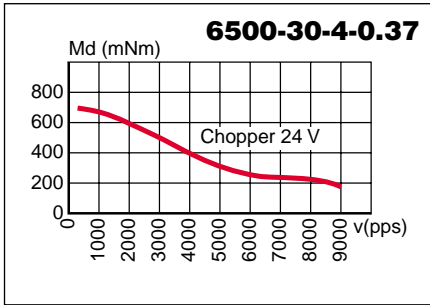
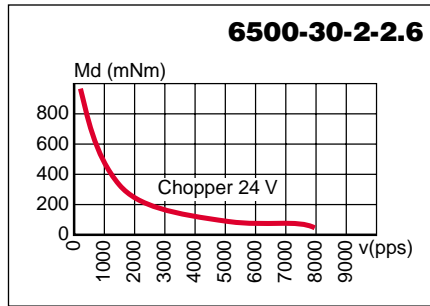
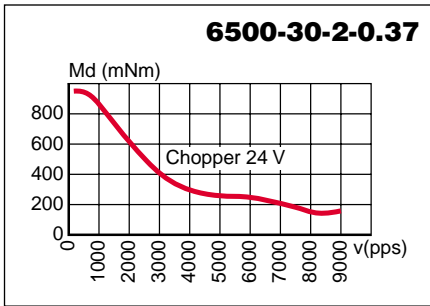

Caractéristiques statiques
Statische Daten
Static characteristics

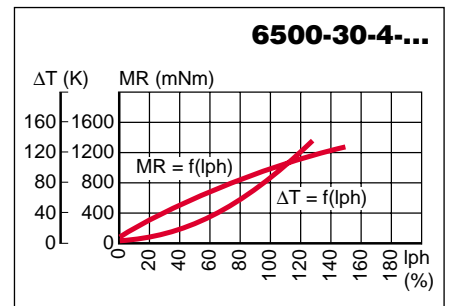
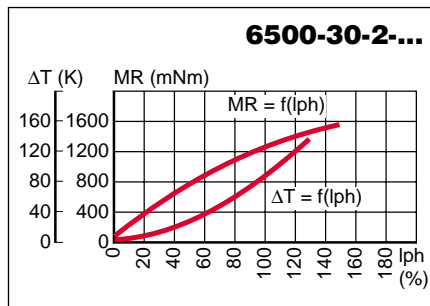

Possibilités d'exécutions adaptées sur demande.
 Auf Wunsch werden kundenspezifische Anforderungen berücksichtigt.
 Special requirements can be made to customer specification.

SONCEBOZ SA
 CH-2605 Sonceboz
 Tél: +41 32 488 11 11
 Fax: +41 32 488 11 00
 E-Mail: info@sonceboz.com
 Internet: www.sonceboz.com

